

# Product Bulletin 286

Technology Solutions Group





**NOTIFICATION Product Release** **Date:** 01.08.2021

Department Building Systems Group

Product AGS 419 Flushline 150mm - Internal & External Rotating Mullions.

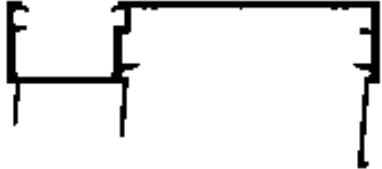
Capral is committed to providing its customers with market leading Window systems. With this Capral would like to introduce the AGS 419 Flushline 150mm - Internal & External Rotating Mullions sections. These have been introduced to enhance the functionality of Capral's framing systems suite.

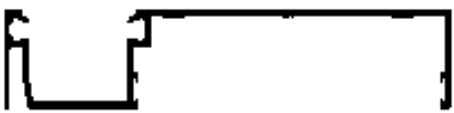
These extrusions form an 'Internal' rotating split mullion with a range of 3° to 6° and an 'External' rotating split mullion with a range of 3° to 8° New extrusions can be combined with the existing 'Straight' split mullion combinations to cater for 0° to 3° by adjusting the glass in the glazing pocket.

<p><u>EP19412</u> MALE INTERNAL ROTATING 38 MULLION 3-6°</p> 	<p><u>EP19413</u> MALE EXTERNAL ROTATING 38 MULLION 3-6°</p> 
<p><u>EP19274</u> FEMALE INTERNAL ROTATING 38 MULLION 3-6°</p> 	<p><u>EP19275</u> FEMALE EXTERNAL ROTATING 38 MULLION 3-6°</p> 

- Internal rotating mullion 3° to 6° .

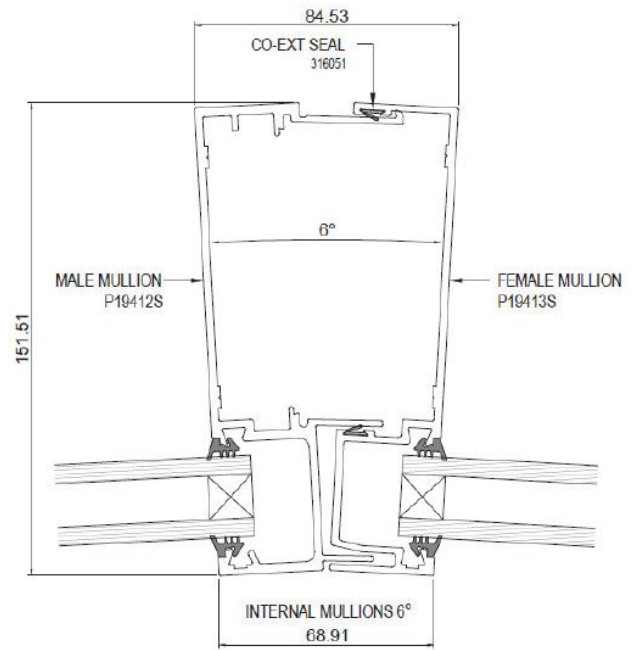
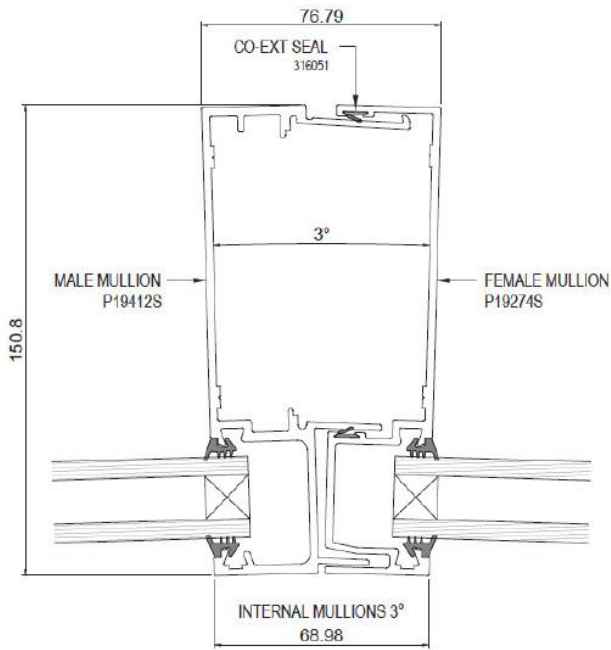

- External rotating mullion 3° to 8° .

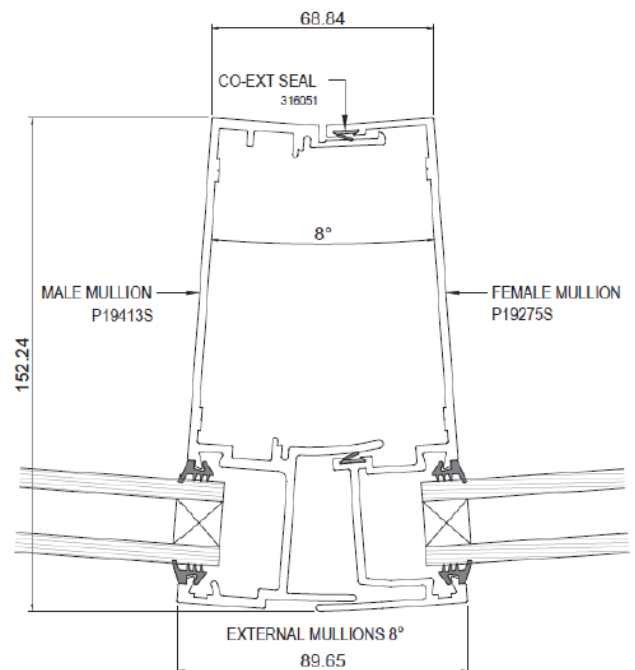
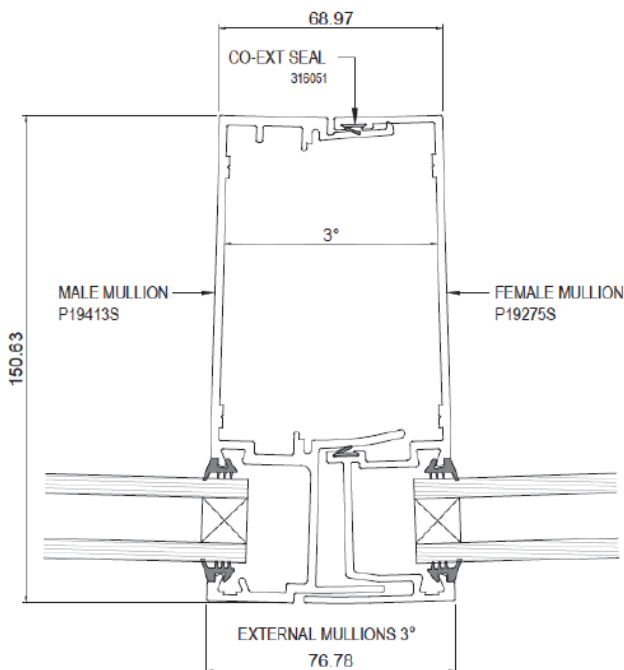

## Stock

These materials are currently available in selected locations, please speak with your local representative for more information

## Technical Manuals

Capral AGS 419 Flushline 150mm Technical Manual is now updated and available to download from the Capral website

## Technical Manuals

These section will be available in future updates of LogiKal and Cre8

Please contact your local Capral representative for further information.



***Matthew Finnie***

National Systems Manager  
Building Systems Group